

# ASSEMBLY INSTRUCTIONS

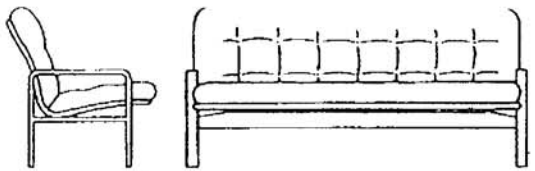

## Sofa & Loveseat

Dear Customer:

Congratulations on your purchase of Brigger furniture from Klein Design. Your piece of furniture will provide you with a lifetime of comfort and enjoyment. Brigger furniture is also easy to assemble. Included you will find all the necessary tools and hardware for you to assemble it yourself. Please check first that all the components have arrived. If not, or if you have any questions regarding assembly, please do not hesitate to contact us.

Gerhart Klein, President

### COMPONENTS

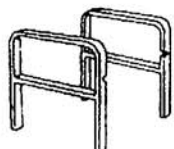

Wood Arms  
(Left & Right)



Front Stretcher



Stretcher Spacers  
(Loveseat: 1;  
Sofa: 2)



Back Stretcher



Seat Pad



Seat Frame



Seat Frame Cover



Extension Tubes



LumBar



Cushion Retainer

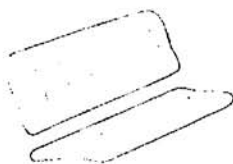

Cushions  
(Back and Seat)

#### HARDWARE



Bolts (4)

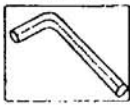

Hex Wrench

## 1. SEAT ASSEMBLY

### STEP 1-A

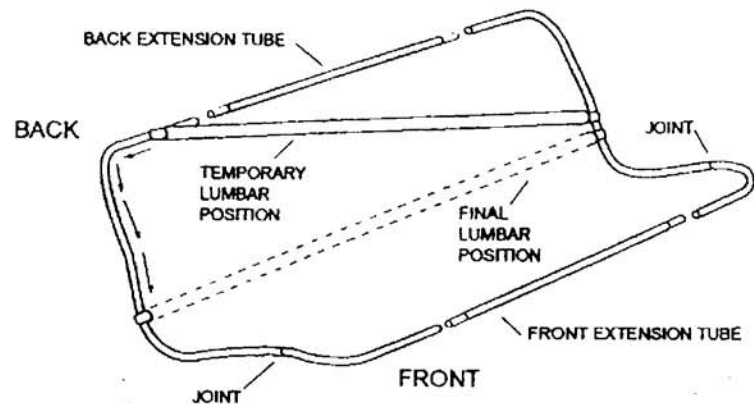

- Cut temporary strap holding seat frame together.
- Separate frame (for sofa, discard tube connecting pieces).
- Place on floor with joints down. Insert front extension tube.
- Place LumBar in temporary position.
- Insert back extension tube. Slide LumBar into final position.

### STEP 1-B

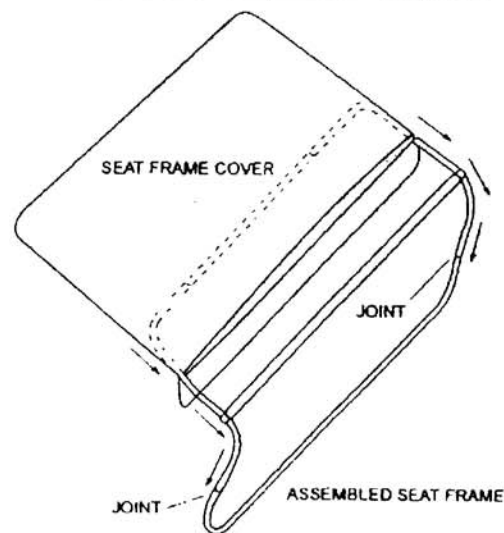

- Hold up assembled seat frame with joints down at floor.
- Pull seat frame cover over frame so zipper closes under seat, near the joints.
- Before closing zipper, place seat pad inside opening.

Toll-free (800) 451-7247  
Fax (978) 526-1623  
Email [kdesign@shore.net](mailto:kdesign@shore.net)

Klein Design, Inc.  
99 Sadler Street  
Gloucester, MA 01930



## 2. BASE ASSEMBLY

### STEP 2-A

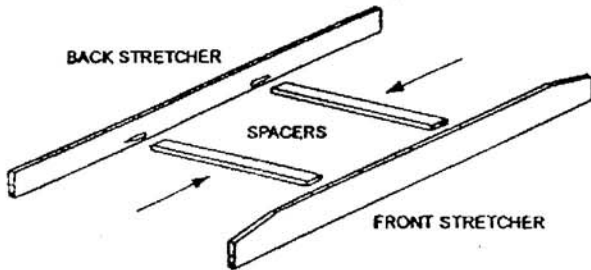

- Temporarily remove plastic thumb screws that block access to the connectors on the front and back stretchers.

- Place front and back stretchers on the floor with tapered connectors down and facing in.
- Engage both ends of the wood spacers with the connectors. Replace thumb screws.

### STEP 2-B

- Attach one of the two wood arms to the stretcher assembly using the bolts and the hex wrench.

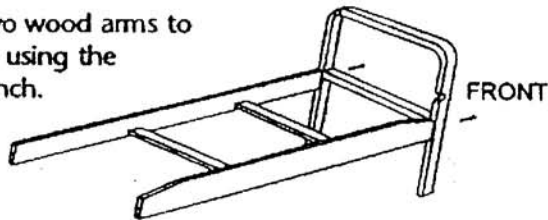

### STEP 2-C

- Stand assembly on its side. Place assembled seat frame in the grooves of the wood arm, making sure the zipper faces the front stretcher underneath the seat.

- Place the second wood arm on top of the seat frame, insert bolts and tighten securely.

*Retightening of bolts:* The bolts may become loose as changes in humidity cause wood to shrink. Keep the hex wrench in the holder behind the front stretcher should retightening become necessary.

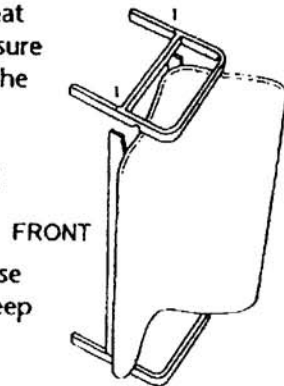

## 3. CUSHIONS

### STEP 3-A

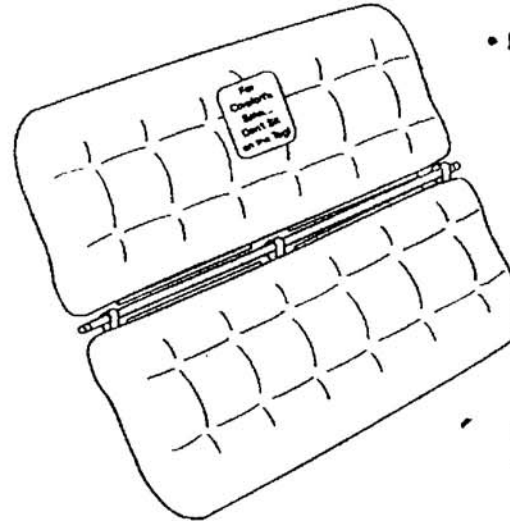

- Engage the zippers on the seat and back cushions. When done correctly, the colored zippers match up.

- Slide the cushion retainer tube through the loops on the back cushion, making sure the tube is behind the zippers.

### STEP 3-B

- Place the attached cushions on the seat, making sure that the back cushion is the one with the tag.

- Slide the ends of the cushion retainer tube into the pockets in the frame cover.

- If desired, unzip the LumBar access zipper behind the back cushion and adjust the height of the LumBar. Sit and enjoy!

